

## NEUHEITEN | NEWS

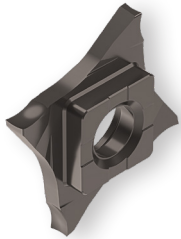

CARBO SX2

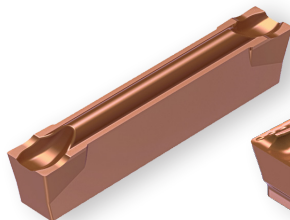

INOXA SX1

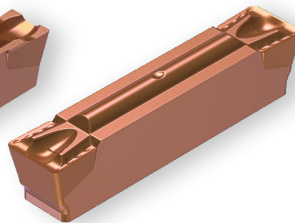

HARD SX3

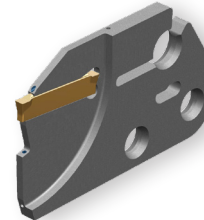

P92 CN R/L

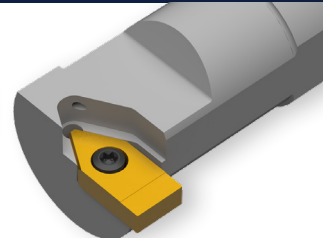

F92 CG R/L

**PKD** und **CBN** für GripLock

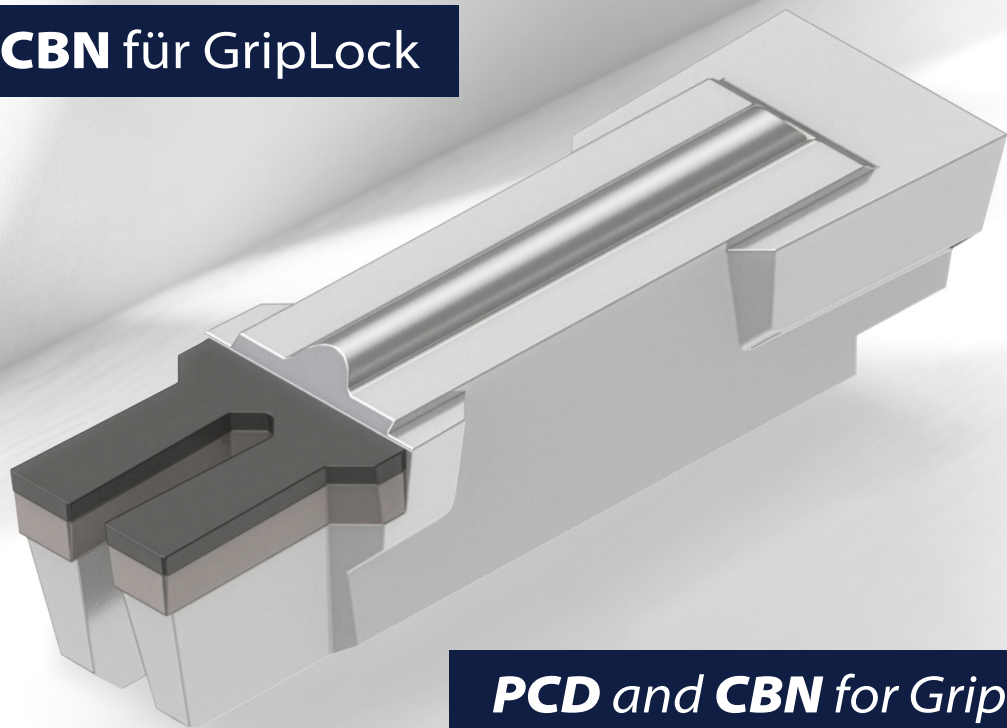

**PCD** and **CBN** for GripLock



Made in Germany

# PKD - bestückte Griplock-Werkzeuge für höchste Standzeiten in NE-Materialien

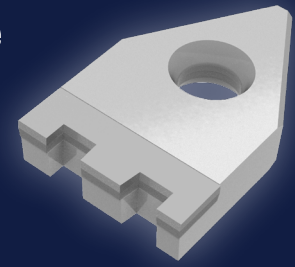

## PCD - tipped Griplock-tools for maximum tool life in non ferrous materials

### PKD (Polykristalliner Diamant) Der ideale Schneidstoff für die Bearbeitung von:

- ▶ Aluminium und Aluminiumlegierungen
- ▶ Kupfer, Messing, Bronze
- ▶ Magnesiumlegierungen
- ▶ Keramik
- ▶ Kunststoffe, inkl. faserverstärkte Kunststoffe (GFK/CFK)
- ▶ Titan
- ▶ Graphit

#### Vorteile:

- ▶ Extrem hohe Härte, dadurch sehr hohe Standzeiten
- ▶ Sehr hohe Schnittgeschwindigkeiten möglich
- ▶ Reduzierung der Bauteilkosten
- ▶ Taktzeitverkürzungen
- ▶ Hohe Lebensdauer

### PCD (polycrystalline diamond) The ideal cutting material for machining:

- ▶ Aluminum and aluminum alloys
- ▶ Copper, brass, bronze
- ▶ Magnesium alloys
- ▶ Ceramics
- ▶ Plastics, including fiber-reinforced plastics (GRP/CFRP)
- ▶ Titanium
- ▶ Graphite

#### Advantages:

- ▶ Extremely high hardness, resulting in very long tool life
- ▶ Very high cutting speeds possible
- ▶ Reduction in component costs
- ▶ Cycle time reductions
- ▶ Long tool life

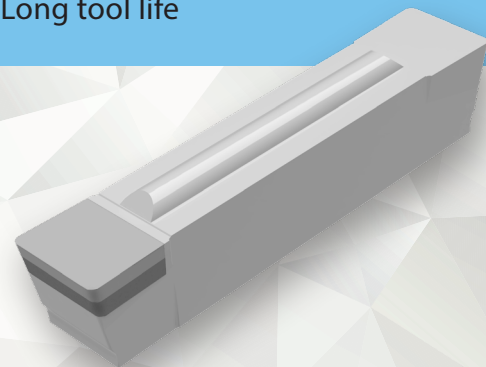

Fragen Sie jetzt Ihr PKD Projekt an!  
*Request your PCD project now!*

sonder@kemmerhmw.de



## CBN - bestückte Griplock-Werkzeuge

Die Lösung für die Bearbeitung anspruchvollster Eisenwerkstoffe

## CBN - tipped Griplock-tools

The solution for machining the most demanding ferrous materials

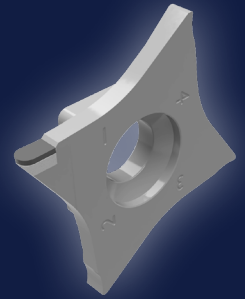

### CBN (kubisch Bornitrid)

Zeigt seine herausragenden Eigenschaften in der Bearbeitung von:

- ▶ Gehärtetem Stahl (bis 68 HRC)
- ▶ Gusseisen, Grauguss
- ▶ Hochharter Weißguss (Hartguss)
- ▶ Sinterstahl
- ▶ Verschleißlegierungen
- ▶ Nickel- und kobaltbasierte Superlegierungen

#### Vorteile:

- ▶ Sehr hohe Warmhärte
- ▶ Verkürzung der Taktzeiten
- ▶ Ersatz für zeitaufwendigen Schleifprozess
- ▶ Reduzierung der Bauteilkosten
- ▶ Vielseitige Gestaltungsmöglichkeit durch CBN-Sorten und Fasen

### CBN (cubic boron nitride)

demonstrates its outstanding properties in the machining of:

- ▶ Hardened steel (up to 68 HRC)
- ▶ Cast iron, gray cast iron
- ▶ High-hardness white cast iron (ductile iron)
- ▶ Sintered steel
- ▶ Wear alloys
- ▶ Nickel- and cobalt-based superalloys

#### Advantages:

- ▶ Very high warm hardness
- ▶ Shortening of cycle times
- ▶ Replacement for time-consuming grinding process
- ▶ Reduction in component costs
- ▶ Versatile design options thanks to CBN grades and chamfers

Fragen Sie jetzt Ihr CBN Projekt an!

Request your CBN project now!

sonder@kemmerhmw.de

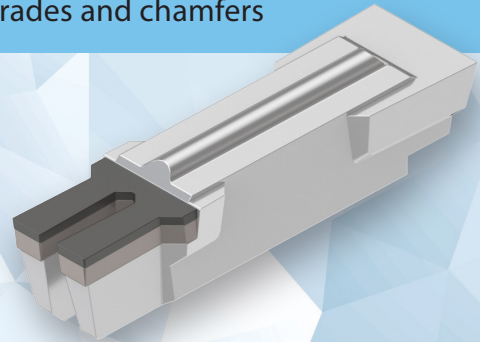

## P92 - Neue Beschichtung - Neue Werkzeuge | *New coating - New toolholders*

2 Schneiden | *2 edges*

### Platten zum Abstechen

*Inserts for parting off*

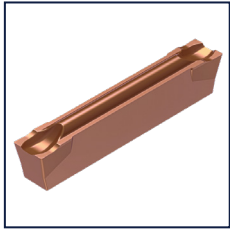

BTNN S. 6

### Platten zum Einstechen und Längsdrehen

*Inserts for grooving*

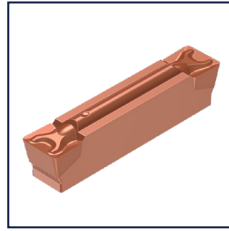

MTNS S. 7

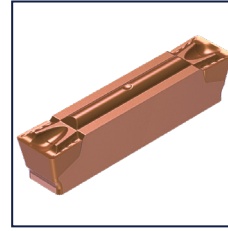

XTNS S. 7-8

### Werkzeuge mit Innenkühlung

*Toolholders with internal coolant*

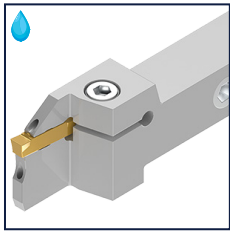

P92 HP...60 S. 9

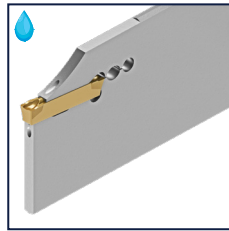

P92 TMS HP...50/60 S. 9

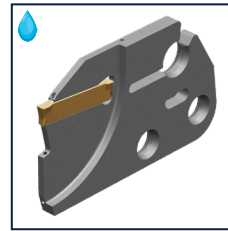

P92 CN XL S. 10

## P92 2 - Neue Platten und Werkzeuge | *New inserts and toolholders*

### Platten für große Tiefen

*Inserts for deep cuts*



AXTNS S. 11

### Axialbearbeitung

*Face grooving*

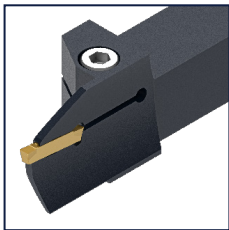

P92 2...30 S. 11

## FLEX FIX - Neue Werkzeuge | *New toolholders*

### Halter mit Innenkühlung für Ø 80

*Holders with internal coolant for Ø 80*

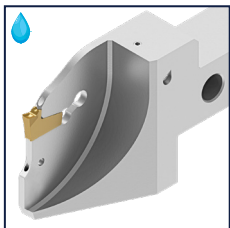

F16 HP S. 12

### GLM D65 Kassetten

*GLM D65 cartridges*

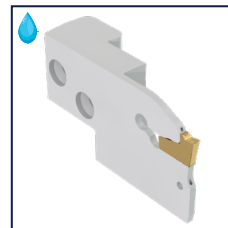

GLM F16 HP S. 12

**MULTICUT 4 - Neue Platten und Werkzeuge | New inserts and toolholders**

4 Schneiden | 4 edges

**Platten zum Ein-/Abstechen**  
*Inserts for grooving/parting off*

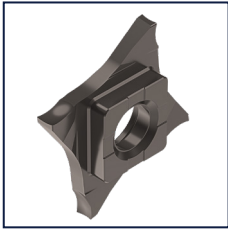

OFQ16L..N/L S. 13

**V Pulley Platten**  
*V Pulley inserts*

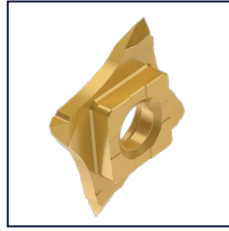

OFQ16R/L..VPJ S. 13

**90° Halter für Linearschlitten**  
*90° holder for linear slides*

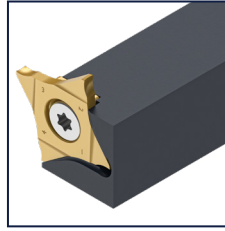

M92 Q 90 FXCBR/L S. 14

**GLS - GripLock SWISS Neue Kassetten | New cartridges**

**Einstechen**  
*Grooving*



GLS OFQE S. 15

**ISO Drehen**  
*ISO Turning*



GLS VB S. 15

**Wechseinheit**  
*Change unit*

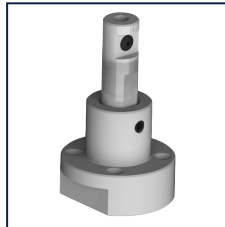

TOOLBOY S. 15

**F92 - Sonderbohrstangen | Special boring bars**

**Bohrstangen für F92 Sonderplatten**  
*Boring bars for F92 special inserts*

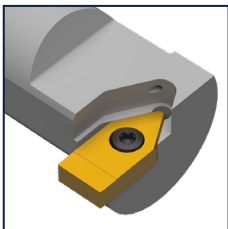

F92 CG S. 17

**GLR - GripLock ROTATION**

**Informationen zum Zirkularfräsen**  
*Information about circular milling*

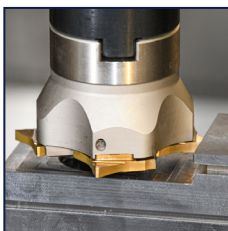

Außen | *External* S. 18

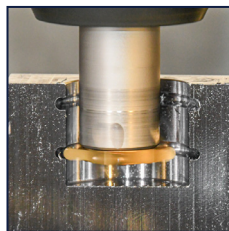

Innen | *Internal* S. 18

# KEMMER Next Generation Coating

## INOXA SX1

### Die Beschichtung für die schwierigen Fälle

Ideale Wahl für die Zerspaltung von rostfreiem Stahl, hochlegiertem Stahl und Titan. Diese glatte HiPIMS-Beschichtung reduziert Reibung und verhindert Aufbauschnitten. Die aus dem hohen Siliziumanteil resultierende Härte sorgt für maximale Standzeiten – selbst unter anspruchsvollsten Bedingungen.

### The coating for difficult applications

Ideal choice for machining stainless steel, high-alloyed steel, and titanium. This smooth HiPIMS coating reduces friction and prevents built-up edges. The hardness resulting from the high silicon content ensures maximum tool life – even under the most demanding conditions.

## Deutliche Vorteile durch HiPIMS Beschichtungsverfahren Significant advantages through HiPIMS coating process

haftungsstärker  
more adhesive

glatter  
smoother

dichter  
denser

## P92 | Stechdrehplatten zum Abstechen Inserts for parting off

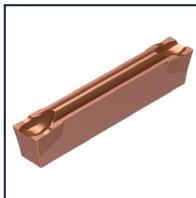

BTNN

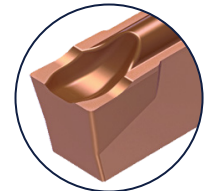
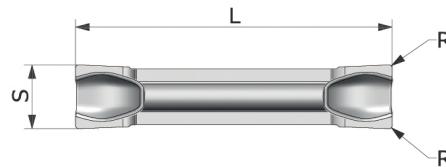

PRODDES	IIC	IH	INSL	RER	REL	CW	CWUD	CWLD	PSIRR	PSIRL	
WG300 Bezeichnung	KM INOXA SX1	Plattensitz- größe	( $\odot$ )	RR	RL	S	S+	S-	$\angle \alpha^\circ$	$\angle \alpha^\circ$	
	<b>MS</b>										
BTNN 1,5	68462	15	N	15,50	0,2	0,2	1,58	0,10	0,10	0	0
BTNN 2	68463	20	N	20,00	0,2	0,2	2,08	0,10	0,10	0	0
BTNN 2,5	68464	20	N	20,00	0,2	0,2	2,58	0,10	0,10	0	0
BTNN 3	68465	30	N	20,00	0,2	0,2	3,08	0,10	0,10	0	0
BTNN 4	68466	40	N	20,00	0,2	0,2	4,08	0,10	0,10	0	0

### BTNN - Abstechen

Genutete Stechschneide mit verstärkten Flanken und geräumiger, muldenförmiger Spankammer. Sehr gute Spankontrolle bei nahezu allen Zerspanungsmaterialien.

### BTNN-Parting off chip breaker

Grooved parting off edge with reinforced flanks. The deep and spacious chip chamber gives excellent chip control. Efficient on almost all materials.

### Passende Werkzeuge | Fitting tool holders

aktueller GripLock Katalog und [hier im Prospekt](#) | [current GripLock Catalogue and here in the brochure](#)



S. 82 - 83



S. 84 - 90



S. 91 - 93



S. 96 - 99



S. 100  
S. 10



S. 101-102



S. 110-113



S. 115-117  
S. 11



S. 119



S. 185



S. 199

## P92 Stechdrehplatten zum Einstechen, Längsdrehen und Abstechen Inserts for grooving, side turning and parting off

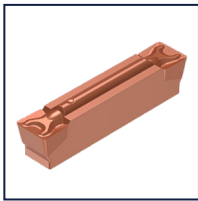

MTNS

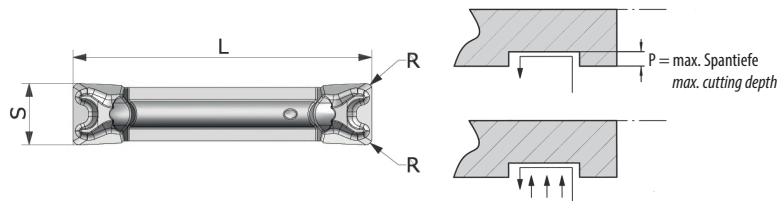

PRODES	IDNR	IIC	IH	INSL	PDPT	REL/RER	CW	CWUD	CWLD
WG300 Bezeichnung	KM INOXA SX1	Plattensitz- größe	(C)	L	P	R	S	S+	S-
	<b>MS</b>								
MTNS 202	68512	20	N	20,10	1,60	0,2	2,09	0,11	-0,11
MTNS 2,5	68513	20	N	20,10	1,60	0,2	2,62	0,05	-0,05
MTNS 302	68514	30	N	20,00	2,80	0,2	3,09	0,09	-0,09
MTNS 304	68515	30	N	20,00	2,80	0,4	3,09	0,09	-0,09
MTNS 402	68516	40	N	20,00	2,80	0,2	4,09	0,12	-0,12
MTNS 404	68517	40	N	20,00	2,80	0,4	4,08	0,12	-0,12
MTNS 408	68518	40	N	20,00	2,80	0,8	4,07	0,14	-0,14
MTNS 504	68519	50	N	25,00	3,40	0,4	5,18	0,13	-0,13
MTNS 508	68520	50	N	25,00	3,40	0,8	5,18	0,13	-0,13
MTNS 604	68521	60	N	30,00	3,90	0,4	6,18	0,13	-0,13
MTNS 608	68522	60	N	30,00	3,90	0,8	6,18	0,13	-0,13

### MTNS-Schruppen

Hauptschneide mit geräumigem Stechspanbrecher. Horizontale Nebenschneiden mit S-förmigen Spanbrechern für exzellente Spankontrolle im Bereich P.  
Besonders geeignet für C- und leg.-Stähle.

### MTNS-Roughing

Cutting edge with large parting off chip breakers. Excellent chip control in the range  $l_s \times 0,8$ .  
Especially recommended for carbon steels, low and high alloy steels.



XTNS

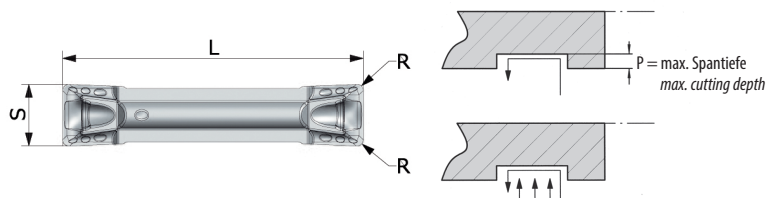

PRODES	IDNR	IIC	IH	INSL	PDPT	REL/RER	CW	CWUD	CWLD
WG300 Bezeichnung	KM INOXA SX 1	Plattensitz- größe	(C)	L	P	R	S	S+	S-
	<b>MS</b>								
XTNS 202	68453	20	N	20,15	1,60	0,2	2,08	0,1	-0,1
XTNS 302	68454	30	N	20,15	2,40	0,2	3,08	0,1	-0,1
XTNS 304	68455	30	N	20,15	2,40	0,4	3,08	0,1	-0,1
XTNS 404	68456	40	N	20,15	2,70	0,4	4,08	0,1	-0,1
XTNS 408	68457	40	N	20,15	2,70	0,8	4,03	0,1	-0,1
XTNS 504	68458	50	N	25,15	3,40	0,4	5,13	0,1	-0,1
XTNS 508	68459	50	N	25,15	3,40	0,8	5,13	0,1	-0,1
XTNS 604	68460	60	N	30,10	3,60	0,4	6,13	0,1	-0,1
XTNS 608	68461	60	N	30,10	3,60	0,8	6,13	0,1	-0,1

### Passende Werkzeuge | Fitting tool holders

aktueller GripLock Katalog und hier im Prospekt | current GripLock Catalogue and here in the brochure



## P92 | Stechdrehplatten zum Einstecken, Längsdrehen und Abstechen Inserts for grooving, side turning and parting off



XTNS

Rechts | right

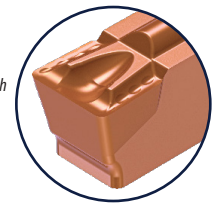
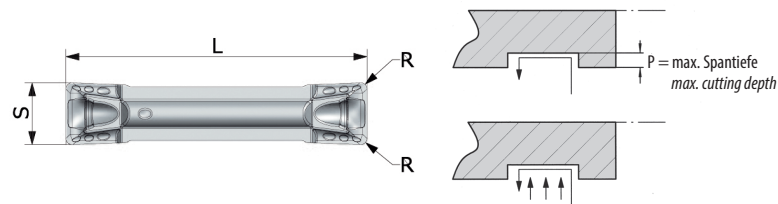

PRODDER	IDNR	IIC	IH	INSL	PDPT	RER/REL	CW	CWUD	CWLD
WG302 Bezeichnung	KM HARDSX3	Plattensitz- größe	( )	L	P	R	S	S+	S-
	<b>H</b>								
XTNS 202	68447	20	N	20,15	1,60	0,2	2,08	0,1	-0,1
XTNS 302	66993	30	N	20,15	2,40	0,2	3,08	0,1	-0,1
XTNS 304	68450	30	N	20,15	2,40	0,4	3,08	0,1	-0,1
XTNS 404	68451	40	N	20,15	2,70	0,4	4,08	0,1	-0,1
XTNS 408	68452	40	N	20,15	2,70	0,8	4,03	0,1	-0,1

### XTNS - Schlichten/Schruppen

9° einlaufende, faserverstärkte Schneidkante und 24° positiver Spanstufen-einlauf erzeugen eine ausgezeichnete Spankontrolle bei langspannenden Werkstoffen.

16° positiver Späneinlauf der Nebenschneiden ermöglichen exzellentes Profildrehen mit sauberen Oberflächen.

### XTNS - Roughing to finishing

A 9° declining major cutting edge with a reinforcing chamfer and a 24° positive entry to the chip former, achieve excellent chip control especially on difficult to cut materials. The minor cutting edges with 16° positive entry angle achieve efficient profile turning creating clean surfaces.

**HARD SX3**

Ideal für die Bearbeitung von harten und schwierigen Materialien. *Perfect for hard machining and difficult operations.*

### Passende Werkzeuge | Fitting tool holders

aktueller GripLock Katalog und [hier im Prospekt](#) | *current GripLock Catalogue and here in the brochure*



S. 83



S. 84 - 90



S. 91 - 93



S. 96 - 99



S. 100  
**S. 10**



S. 101-102



S. 110-113



S. 115-117  
**S. 11**



S. 119



S. 185



S. 199

**P92 | Halter mit Innenkühlung für Stechbreite 6 mm, kurze Auslage**  
*Holder with internal coolant for cutting width 6 mm, short extension*

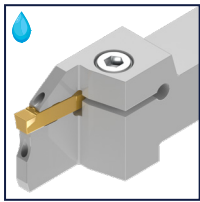

P92 CXCBL 60 HP

Links | *left*

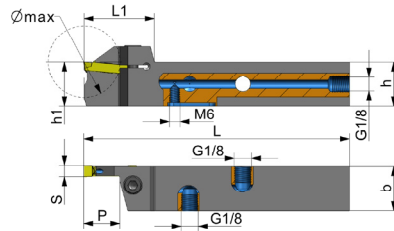

P92 CXCBR 60 HP

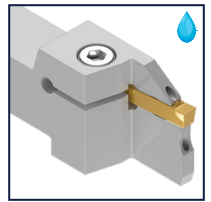

Rechts | *right*

PRODDES	IDNR	MIID	Hand	H	HF	B	CDX	CW	OAL	LH	LTA				
WG3805 Bezeichnung	ID-Nr.	Plattensitz- größe	( )	G	Ø max	h	h1	h2	b	P	S	L	L1	L2	
P92 CXCBL 1616 K60 10 HPG1/8	68396	60	L	G1/8	20	16	16	5	16	10	6,0	125	32	31,5	1
P92 CXCBL 2020 K60 10 HPG1/8	68398	60	L	G1/8	20	20	20	5	20	10	6,0	125	32	31,5	1
P92 CXCBR 1616 K60 10 HPG1/8	68397	60	R	G1/8	20	16	16	5	16	10	6,0	125	32	31,5	1
P92 CXCBR 2020 K60 10 HPG1/8	68399	60	R	G1/8	20	20	20	5	20	10	6,0	125	32	31,5	1

Stechhalter mit kurzer Stechtiefe und Kühlung oben + unten.

*Toolholder with short cutting depth and internal coolant.*

**Passende Platten | Fitting inserts**

Aktueller GripLock Katalog | *Current GripLock catalogue*  
und hier im Prospekt | *and here in the brochure*

Optimale Geometrieauswahl mit Stechbreiten 6 mm, z.B. zum Einstechen und Längsdrehen:  
*Optimal geometry selection for cutting widths of 6 mm, e.g. for grooving and side turning:*



**P92 | TWIN SCHWERT Abstechträger mit Innenkühlung**  
*TWIN BLADES parting off blades with internal coolant*

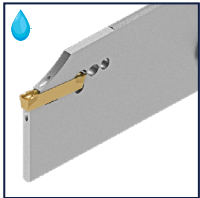

P92 TMS HP

Links | *left*

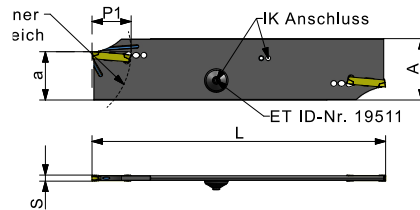

PRODDES	IDNR	MIID	Hand	H	HF	CDX	CW	OAL	
WG3105 Bezeichnung	ID-Nr.	Plattensitz- größe	( )	A	a	P1	S	L	
P92 TMS 32 50 HP	57321	50	N	32	25,0	23,5	5,0	150	28
P92 TMS 32 60 HP	57322	60	N	32	25,0	28,5	6,0	150	28

Abstechschwerter mit Selbstklemmung und Kühlung.

*Parting off blades with self-clamping and internal coolant.*

**Passende Platten | Fitting inserts**

Aktueller GripLock Katalog | *Current GripLock catalogue*  
und hier im Prospekt | *and here in the brochure*

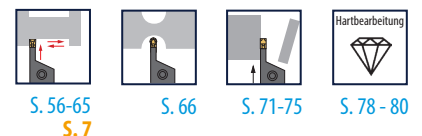

## P92 | Abstechkassetten zur Direktaufnahme mit Innenkühlung Cartridges for parting off with internal coolant

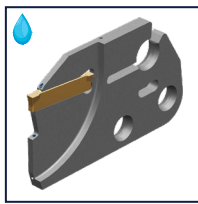

P92 CN XL...HP

Links | *left*

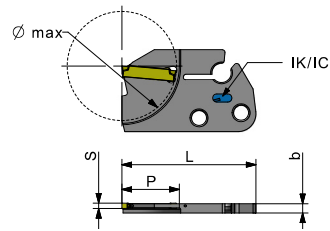

P92 CN XR...HP

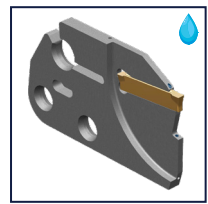

Rechts | *right*

PRODDES	IDNR	MIID	Hand	CODX	B	CW	OAL	CDX	
WGRGL3865 Bezeichnung	ID-Nr.	Plattensitz- größe	( )	Ømax	b	S	L	P	
P92 CN L XL20+25 D32 HP	64740	20+25	L	32	3,4	2,0+2,5	49	16	-
P92 CN L XL20+25 D42 HP	64739	20+25	L	42	3,4	2,0+2,5	49	21	-
P92 CN L XL30 D42 HP	64741	30	L	42	3,4	3,0	49	21	-
P92 CN R XL20+25 D32 HP	64738	20+25	R	32	3,4	2,0+2,5	49	16	-
P92 CN R XL20+25 D42 HP	64737	20+25	R	42	3,4	2,0+2,5	49	21	-
P92 CN R XL30 D42 HP	62717	30	R	42	3,4	3,0	49	21	-

Abstechkassetten ohne Positionsnut zur Direktaufnahme.  
Direkte Kühlung der Schneide von oben und von unten.

*Parting off cartridges without a positioning groove for direct mounting.  
Direct cooling of the cutting edge from above and below.*

Zur Direktadaption auf passenden Modulen für z.B.:

- ▶ VDI
- ▶ TRAUB
- ▶ INDEX
- ▶ ...

*Direct SET UP on adapters for e.g.:*

- ▶ VDI
- ▶ TRAUB
- ▶ INDEX
- ▶ ...



## Perfekte Kombination | *Perfect fit*

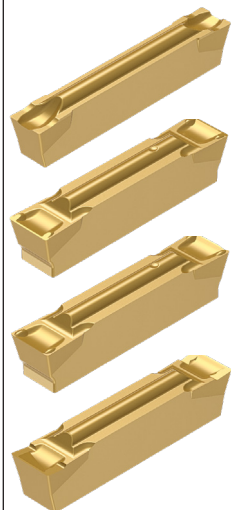

**BTNN** | Der Abstech-Allrounder | *the overall solution for parting off*

**CTD** | Ideal für unterbrochene Schnitte | *perfect for interrupted cuts*

**SCTD** | Zum Abstechen von Stahllegierungen | *for parting off alloyed steel*

**CTD ALU** | Für Nichteisenmetalle & Rohre | *for non-ferrous material & tubes*

### Passende Platten | *Fitting inserts*

Aktueller GripLock Katalog | *Current GripLock catalogue*  
und hier im Prospekt | *and here in the brochure*



S. 56-65  
S. 7



S. 66



S. 68-76  
S. 6



S. 78-80  
S. 8

## P92 Stechdrehplatten für große Tiefen Grooving inserts for deep cuts



A XTNS

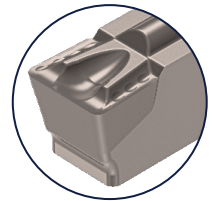
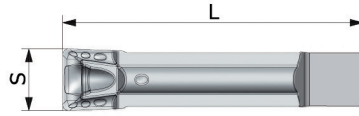

PRODDES	IDNR	IIC	IH	INSL	REL/RER	CW	CWUD	CWLD
WG300 Bezeichnung	KM TILOX	Plattensitz- größe	( )	L	R	S	S+	S-
	<b>P M K S</b>							
A XTNS 302	68422	30	N	20,00	0,2	3,080	0,10	-0,10
A XTNS 404	68423	40	N	20,00	0,4	4,080	0,10	-0,10
A XTNS 504	68424	50	N	25,00	0,4	5,130	0,10	-0,10
A XTNS 604	68425	60	N	30,00	0,4	6,130	0,10	-0,10

A XTNS - Schlichten/Schruppen für tiefe Konturen beim Stechen, Abstechen oder Axialstechdrehen (abgesetzte Schneide)

*A XTNS - Roughing to finishing for deep cuts in grooving, parting off or face grooving applications (modified edge)*

aktueller GripLock Katalog und hier im Prospekt | *current GripLock Catalogue and here in the brochure.*

**Passende Werkzeuge | Fitting tool holders**

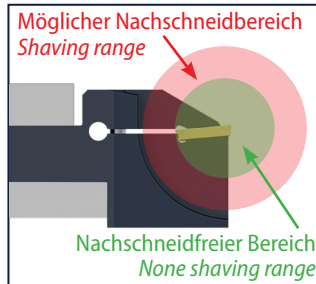

### Nachschneideffekt

Nachschneiden kann entstehen, wenn bei großen Stechtiefen die zweite Schneide in die gestochene Nut eindringt. Falls erforderlich, kann dieser Effekt durch den Einsatz einer einseitig abgesetzten Stechplatte verhindert werden.

### Shaving

*If the cutting depth exceeds the length of the cutting insert, the second edge of the insert penetrates into the shot and may cause shaving marks on the component. To prevent from shaving the insert type A is recommended.*

## P92 2 Axialstechen Erweiterungen Face grooving new products

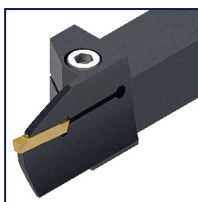

P92 2 CXCB L

Links | *left*

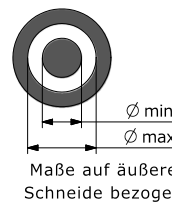
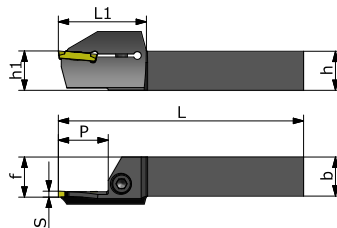

P92 2 CXCB R

Rechts | *right*

PRODDES	IDNR	MIID	Hand	DAXN	DAXX	H	HF	B	WF	CDX	CW	OAL	LH
WG388 Bezeichnung	ID-Nr.	Plattensitz- größe	( )	Ø min	Ø max	h	h1	b	f	P	S	L	L1
P92 2 CXCB L 2525 M 30 200	68226	30	L	200	450	25	25	25	25,5	25	3	150	45
P92 2 CXCB L 2525 M 30 450	68228	30	L	450	∞	25	25	25	25,5	25	3	150	45
P92 2 CXCB R 2525 M 30 200	68227	30	L	200	450	25	25	25	25,5	25	3	150	45
P92 2 CXCB R 2525 M 30 450	68229	30	L	450	∞	25	25	25	25,5	25	3	150	45

Axialstechhalter für Einstechdurchmesser ab  $\varnothing \geq 200$  mm. *Face grooving holders for diameters starting  $\varnothing \geq 200$  mm.*

**Passende Platten | Fitting inserts**

Aktueller GripLock Katalog und hier im Prospekt | *Current GripLock catalogue and here in the brochure*

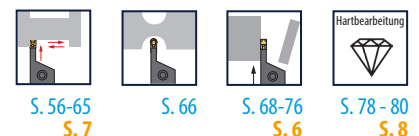

## FLEX FIX | Erweiterungen und Neuheiten

### New products

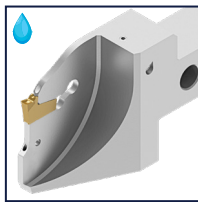

F16 L 80 HP

Links | *left*

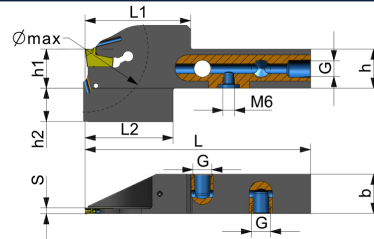

F16 R 80 HP

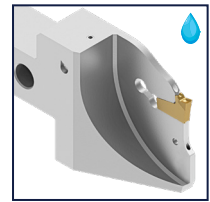

Rechts | *right*

PRODDES	IDNR	MIID	Hand	H	HF	B	CW	OAL	LH	LTA				
WG3205 Bezeichnung	ID-Nr.	Plattensitz- größe	G	( )	Ø max	h	h1	h2	b	S	L	L1	L2	
F16 L 2020 K30 80HP G1/8	67825	FF3	G1/8	L	80	20	20	17	20	3,0	125	54	45	AWF16
F16 L 2525 M30 80HP G1/8	67827	FF3	G1/8	L	80	25	25	12	25	3,0	150	54	45	AWF16
F16 R 2020 K30 80HP G1/8	67826	FF3	G1/8	R	80	20	20	17	20	3,0	125	54	45	AWF16
F16 R 2525 M30 80HP G1/8	67828	FF3	G1/8	R	80	25	25	12	25	3,0	150	54	45	AWF16

Abstechhalter mit Innenkühlung  
für Durchmesser bis 80 mm.

*Toolholder with internal coolant for  
parting off diameter up to 80 mm.*

**Passende Platten | Fitting inserts**  
Aktueller GripLock Katalog | *Current GripLock catalogue*



S. 161-163

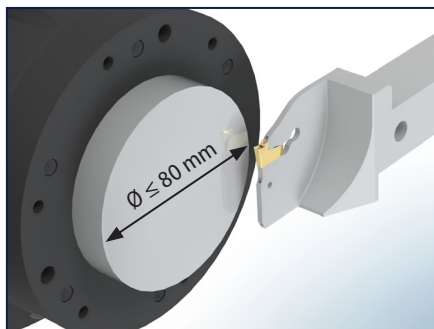

### CHECK bei tiefen Abstechoperationen

- ▶ Stabile Spannung
- ▶ Zielgerichtete Kühlung
- ▶ Passende Spanbrecher & Schnittwerte

### CHECK for deep parting off operations

- ▶ *Stable clamping*
- ▶ *Effective coolant*
- ▶ *Suitable chip breakers & cutting parameters*

## FLEX FIX | Neue Abstechkassetten mit Innenkühlung bis D 65 mm

### New cartridges for parting off with internal coolant up to D 65 mm

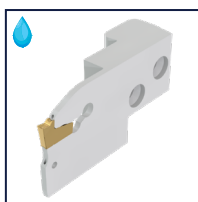

GLMCL F16 65 HP

Links | *left*

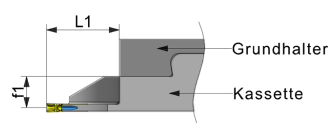
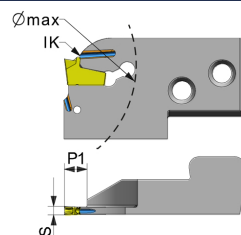

GLMCR F16 65 HP

Rechts | *right*

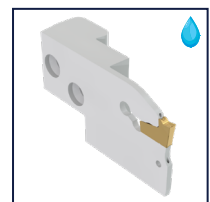

PRODDES	IDNR	MIID	Hand	CDX	LH	CODX	CW	WF	
WG5105 Bezeichnung	ID-Nr.	Plattensitz- größe	( )	P1	L1	Ø max	S	f1	
GLMCL F16 30 65 HP	68439	FF3	L	20	33,5	65	3	10,8	AWF16
GLMCR F16 30 65 HP	68440	FF3	R	20	33,5	65	3	10,8	AWF16

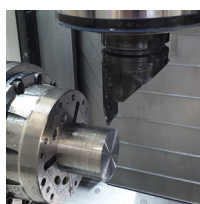

Für Komplettbearbeitungszentren  
und Drehautomaten bis D 65 mm.

*For machining centres and turning  
machines up to D 65 mm.*

**Passende Platten | Fitting inserts**  
Aktueller GripLock Katalog | *Current GripLock catalogue*



S. 161-163



S. 180



S. 182-183

## MULTICUT 4 | Ein-/Abstechplatten mit neuer Beschichtung Inserts for grooving and parting off with new coating

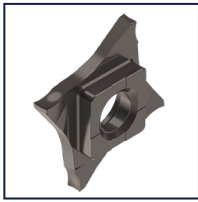

OFQ16L..N

Links | *left*

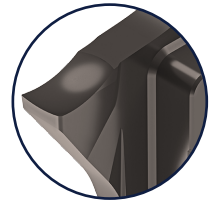
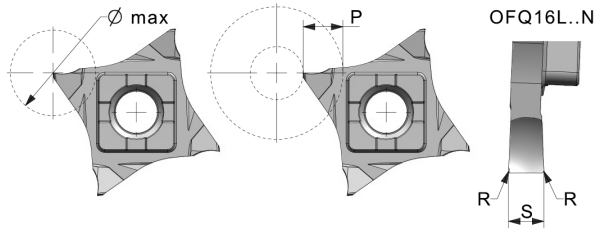

PRODDES	IDNR	IIC	IH	PDPT	REL/RER	CW	CWUD	CWLD	PSIRR	PSIRL	
WG400 Bezeichnung	FM CARBOSX2	Plattensitz- größe	( )	P	R	S	S+	S-	$\alpha^\circ$ R	$\alpha^\circ$ L	$\varnothing$ max.
	<b>P</b>										
OFQ16L 120 000 N 00	65210	16L	N	6,5	0,00	1,20	0,05	0,00	0	0	13,0
OFQ16L 150 010 N 00	65214	16L	N	6,5	0,10	1,50	0,05	0,00	0	0	13,0
OFQ16L 200 010 N 00	65218	16L	N	6,5	0,10	2,00	0,05	0,00	0	0	13,0
OFQ16L 200 020 N 00	65221	16L	N	6,5	0,20	2,00	0,05	0,00	0	0	13,0
OFQ16L 250 010 N 00	65222	16L	N	6,5	0,10	2,50	0,05	0,00	0	0	13,0
OFQ16L 250 020 N 00	65224	16L	N	6,5	0,20	2,50	0,05	0,00	0	0	13,0
OFQ16L 300 010 N 00	65225	16L	N	6,5	0,10	3,00	0,05	0,00	0	0	13,0
OFQ16L 300 020 N 00	65227	16L	N	6,5	0,20	3,00	0,05	0,00	0	0	13,0

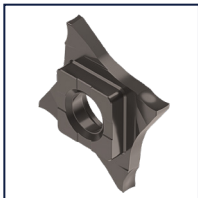

OFQ16R..N

Rechts | *right*

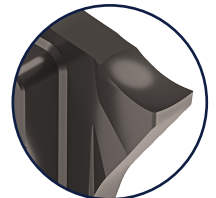
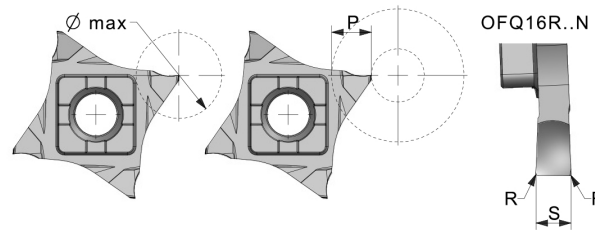

PRODDES	IDNR	IIC	IH	PDPT	REL/RER	CW	CWUD	CWLD	PSIRR	PSIRL	
WG 400 Bezeichnung	FM CARBOSX2	Plattensitz- größe	( )	P	R	S	S+	-	$\alpha^\circ$ R	$\alpha^\circ$ L	$\varnothing$ max.
	<b>P</b>										
OFQ16R 120 000 N 00	67368	16R	N	6,5	0,00	1,20	0,05	0,00	0	0	13,0
OFQ16R 150 010 N 00	67369	16R	N	6,5	0,10	1,50	0,05	0,00	0	0	13,0
OFQ16R 200 010 N 00	67370	16R	N	6,5	0,10	2,00	0,05	0,00	0	0	13,0
OFQ16R 200 020 N 00	67371	16R	N	6,5	0,20	2,00	0,05	0,00	0	0	13,0
OFQ16R 250 010 N 00	67372	16R	N	6,5	0,10	2,50	0,05	0,00	0	0	13,0
OFQ16R 250 020 N 00	67373	16R	N	6,5	0,20	2,50	0,05	0,00	0	0	13,0
OFQ16R 300 010 N 00	67374	16R	N	6,5	0,10	3,00	0,05	0,00	0	0	13,0
OFQ16R 300 020 N 00	67375	16R	N	6,5	0,20	3,00	0,05	0,00	0	0	13,0

Segmentierter und geschliffener Schneidkörper aus Feinkornhartmetall.  
Positiver Spanwinkel mit muldenförmiger Spankammer ab S = 1,5 mm.  
Ideal für alle Arten der Stahlzerspanung.  
Neueste Beschichtungstechnologie für Hochleistungsanwendungen.

*Segmented and ground micrograin insert. Positive top-rake with chipforming groove, beginning with 1,5 mm width to 3 mm.  
Perfect for all kinds of steel applications.  
State of the art coating technologies for high performance applications.*

**CARBO SX2**

HiPIMS Beschichtung zur Bearbeitung von  
niedrig- und hochlegierten Stählen.

*HiPIMS coating for machining low- and  
high-alloyed steel.*

**Passende Werkzeuge | Fitting tool holders**

aktueller GripLock Katalog und [hier im Prospekt](#) | [current GripLock Catalogue](#) and [here in the brochure](#)



S. 47



S. 48



S. 48



S. 184



S. 198

S. 14

## MULTICUT 4 | V PULLEY

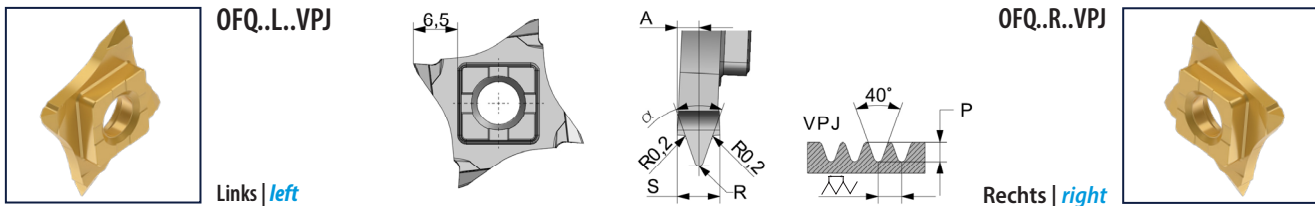

PRODDES	IDNR	IIC	IH	TPN	PDX	CRE	CDX	CW	PNA
WG400 Bezeichnung	FM NANOSPEED	Plattensitz- größe	(C)		A	R	P	S	$\alpha^\circ$
OFQ16L 300 030 VPJ FM NANOSPEED	68413	16L	L	2,34	1,5	0,3	2,25	3,0	40
OFQ16L 300 030 VPJX FM NANOSPEED	68414	16L	L	-	1,5	0,3	3,40	3,0	40
OFQ16R 300 030 VPJ FM NANOSPEED	68415	16R	R	2,34	1,5	0,3	2,25	3,0	40
OFQ16R 300 030 VPJX FM NANOSPEED	68416	16R	R	-	1,5	0,3	3,40	3,0	40

Typ VPJ mit Verrundung der Auslaufradien am Übergang zum nächsten Profil.  
 Typ VPJX ohne Verrundung der Auslaufradien; flexible Tiefe bis Maß P  
 (auch zum Vorstechen geeignet)

Type VPJ with rounded run-out radii at the transition to the next profile.  
 Type VPJX without rounded run-out radii; flexible depth up to dimension P  
 (also suitable for pre-grooving)

**Passende Werkzeuge** | *Fitting tool holders*  
 aktueller GripLock Katalog | *current GripLock Catalogue*  
 und hier im Prospekt | *and here in the brochure*

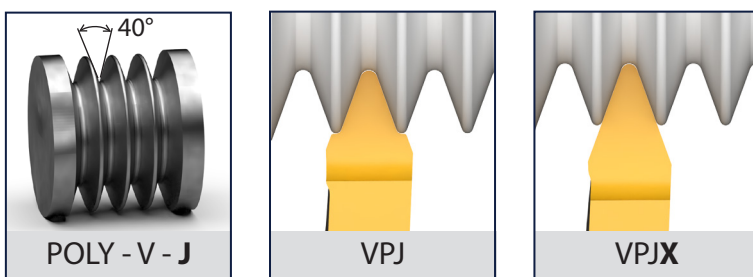
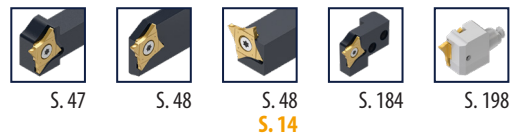

## MULTICUT 4 | Halter 25 x 25 für Drehmaschinen mit Linearschritten Holder 25 x 25 for lathes with linear slides

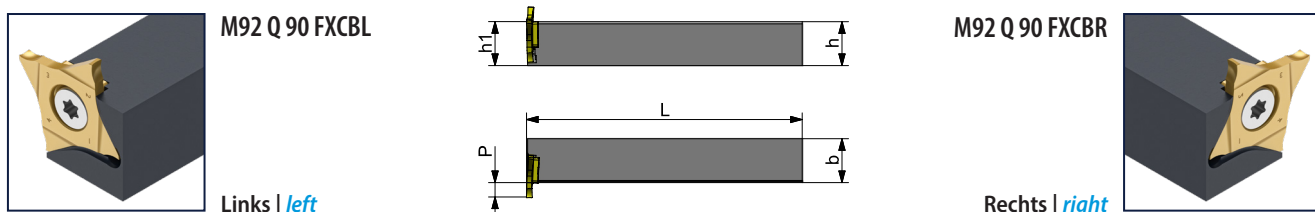

PRODDES	IDNR	MIID	Hand	H	HF	B	CDX	OAL
WG402 Bezeichnung	ID-Nr.	Plattensitz- größe	(C)	h	h1	b	P	L
M92 Q 90 FXCBL 2525 M16	67236	16L	L	25	25	25	6,5	150
M92 Q 90 FXCBR 2525 M16	67237	16R	R	25	25	25	6,5	150

### Hinweis 90° Halter

Auf rechte Halter passen nur linke Schneidkörper  
 und auf linke Halter nur rechte Schneidkörper.

### Remark 90° holders:

Only LH inserts for RH holder and  
 RH inserts for LH holders.

**Passende Platten** | *Fitting inserts*  
 Aktueller GripLock Katalog | *Current GripLock catalogue*  
 und hier im Prospekt | *and here in the brochure*

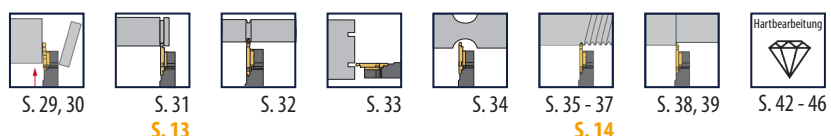

## GLS | GripLock SWISS Erweiterungen und Neuheiten GripLock SWISS new products



GLS L M92QE

**EXTENDED VERSION**

Links | *left*

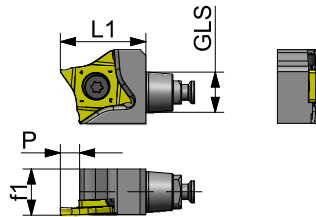

GLS R M92QE

**EXTENDED VERSION**

Rechts | *right*

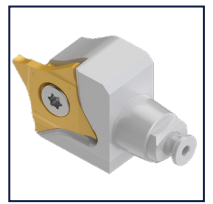

PRODDES	IDNR	MIID	Hand	CDX	LH	WF	
<b>WG805 Bezeichnung</b>	<b>ID-Nr.</b>	<b>GLS</b>	<b>Plattensitz- größe</b>	<b>( )</b>	<b>P</b>	<b>L1</b>	<b>f1</b>
GLS4 CL M92QE X16	66459	GLS4	16EL	L	6,5	23	8,3 33+39+40
GLS4 CR M92QE X16	66457	GLS4	16ER	R	6,5	23	8,3 33+39+40

GLS Kassetten für Ausführung MULTICUT „EXTENDED“

GLS cartridge for insert version MULTICUT „EXTENDED“

**Passende Werkzeuge und Platten | Fitting toolholders and inserts**

Aktueller GripLock Katalog [und hier im Prospekt](#) | *Current GripLock catalogue and here in the brochure*

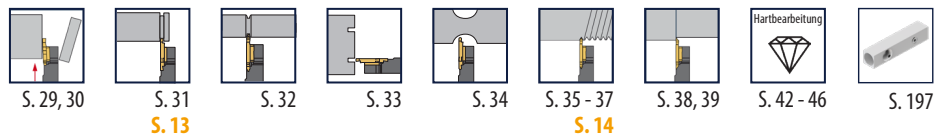

## GLS GripLock SWISS | ISO Kassetten ISO cartridges



GLS..CL VB..HP

Links | *left*

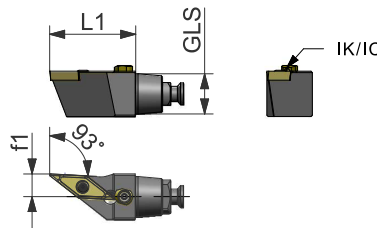

GLS..CR VB..HP

Rechts | *right*



PRODDES	IDNR	Hand	LH	WF	MIID	
<b>WG810 Bezeichnung</b>	<b>ID-Nr.</b>	<b>GLS</b>	<b>( )</b>	<b>L1</b>	<b>f1</b>	<b>Wendeplatten- größe / insert</b>
GLS4 CL VJB C11 25 HP	67812	GLS4	L	25	6,0	VB1103 s. GL Kat.
GLS4 CR VJB C11 25 HP	67811	GLS4	R	25	6,0	VB1103 s. GL Kat.

GLS Kassetten für ISO Drehplatten VB11...

GLS cartridges for ISO inserts VB11..

**Passende Aufnahmen | Fitting toolholders**

Aktueller GripLock Katalog | *Current GripLock catalogue*



S. 197

## GLS GripLock SWISS | TOOLBOY

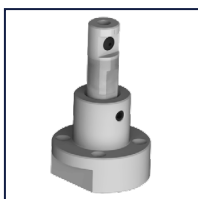

GLS TOOLBOY

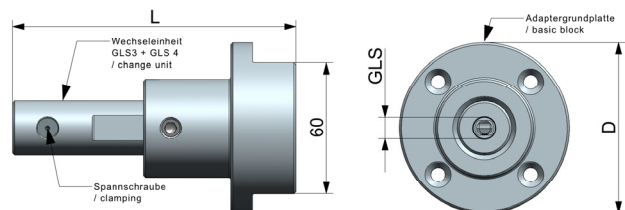

PRODDES	IDNR	Hand	DCONMS	OAL	
<b>WG800 Bezeichnung</b>	<b>ID-Nr.</b>	<b>( )</b>	<b>GLS</b>	<b>D</b>	<b>L</b>
GLS TOOLBOY	66523	N	3+4	78	130 s. GL Kat.

## GLS | Plattenwechsel & Handling *Insert change & handling*

Der Adapter verfügt über eine integrierte Wechseinheit mit Anschlussgröße GLS 3 oder GLS 4 an den jeweiligen Enden.

**Wechseinheit hierzu drehen.**

*The integrated changing unit includes the interface sizes GLS3 or GLS 4 on each side.*

*The unit therefore has to be turned to the opposite front face.*

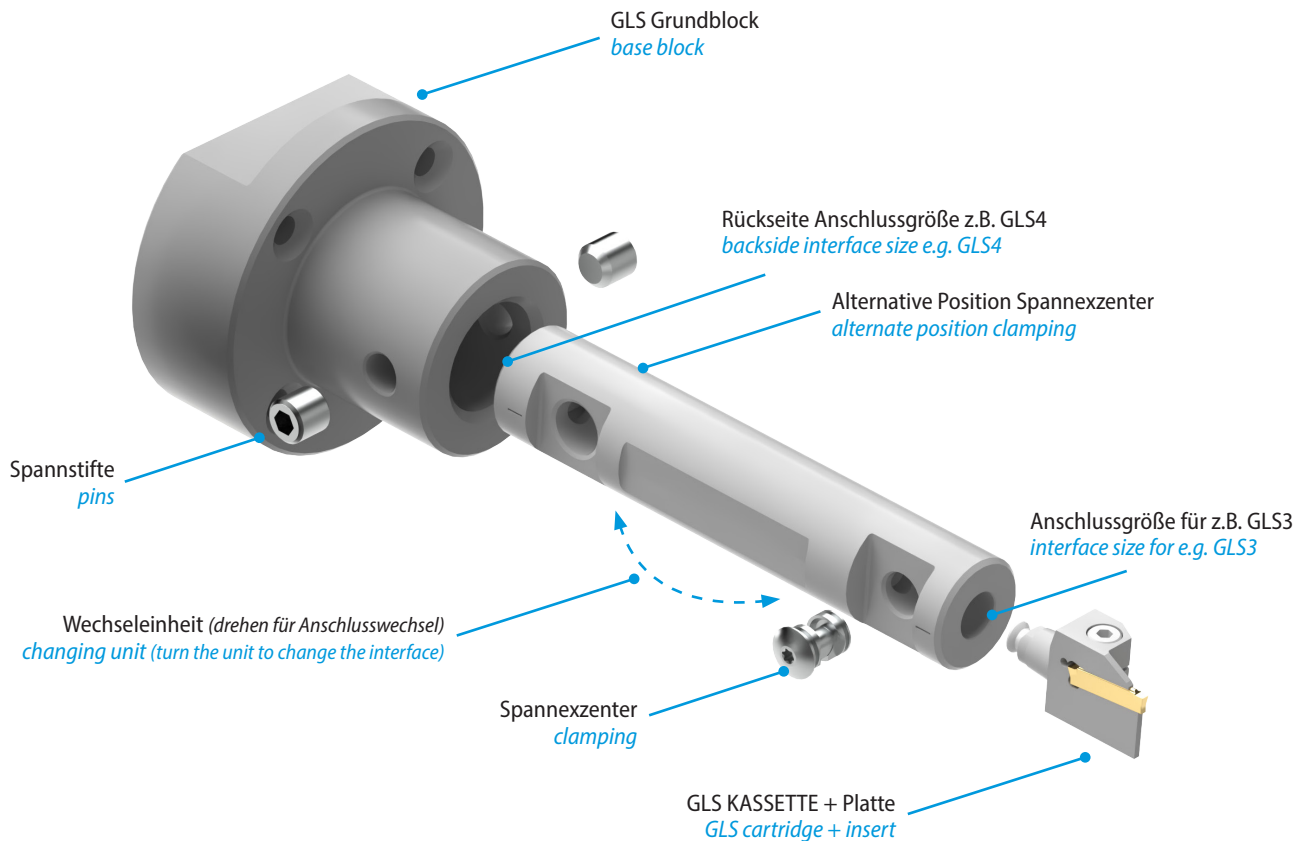

**Sicheres und einfaches Wechseln der (Stech-) Wendeplatte, auch außerhalb der Maschine!**

*Safe and easy insert change even outside the machining area!*



## F92 | Sonderbohrstangen Special boring bars

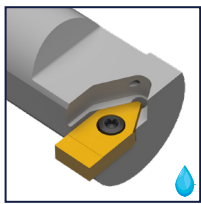

F92 CGL

Links | *left*

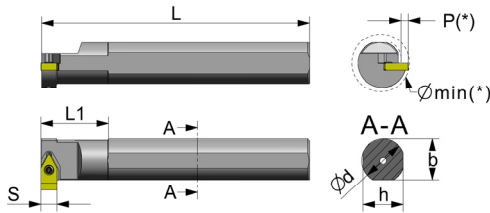

F92 CGR

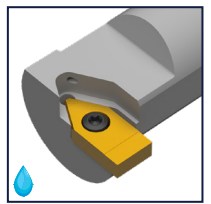

Rechts | *right*

PRODDES	IDNR	MIID	Hand	DMIN	DCONMS	H	B	CDX	CW	OAL	LH	
WG360 Bezeichnung	ID-Nr.	Plattensitz- größe	(C)	Ømin (*)	Ø d	h	b	P(*)	S(*)	L	L1	
F92 CGL 0020 M...	a. A.	F13	L	32	20	18	19	9	12... 20	150	-	25
F92 CGL 0025 R...	a. A.	F13	L	33	25	23	23	7	12... 20	200	-	25
F92 CGL 0032 R...	a. A.	F13	L	40	32	30	30	7	12... 30	200	50	25
F92 CGL 0040 S...	a. A.	F13	L	46	40	38	38	5	12... 30	250	64	25
F92 CGR 0020 M...	a. A.	F13	R	32	20	18	19	9	12... 20	150	-	25
F92 CGR 0025 R...	a. A.	F13	R	33	25	23	23	7	12... 20	200	-	25
F92 CGR 0032 R...	a. A.	F13	R	40	32	30	23	7	12... 30	200	50	25
F92 CGR 0040 S...	a. A.	F13	R	46	40	38	38	5	12... 30	250	64	25

a. A. - auf Anfrage | *on request*

\* abhängig eingesetzter (Sonder-) Stechplatte  
*\* depends on assembled (special-) insert*

Standardabmaße für kurzfristig lieferbare TAILORMADE Bohrstangen  
(abweichende Abmaße können individuell angefragt werden)

*Standard dimensions for TAILORMADE boring bars with short lead times  
(for other dimension separate quotations can be provided)*



IK seitlich D20 - D40  
*IC lateral D20 - D40*



IK direkt D32/40  
*IC direct D32/40*

Dank neuester Technologie und Standardisierung ist Ihr individuelles Sonderprojekt kurzfristig (!) lieferbar.

*Based on latest technologies and standardization these TAILOR MADE boring bars are shortly (!) available for your individual demand.*

Wahlweise auch ohne IK | *also without coolant*

## F92 | Innensonderkonturen Special profiles for internal machining

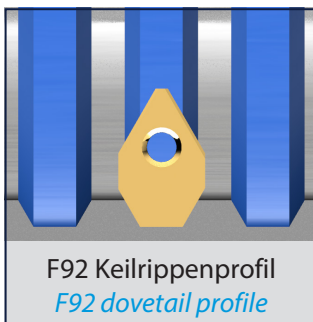

F92 Keilrippenprofil  
*F92 dovetail profile*

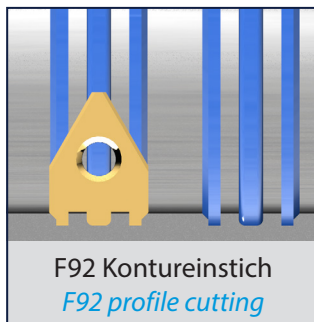

F92 Kontureinstich  
*F92 profile cutting*

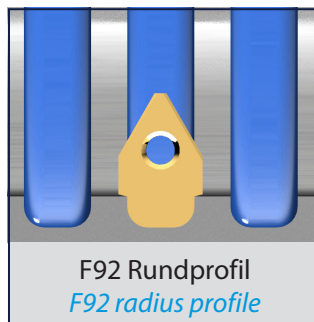

F92 Rundprofil  
*F92 radius profile*

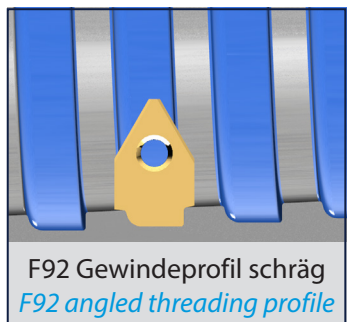

F92 Gewindeprofil schräg  
*F92 angled threading profile*

- ▶ Konturenbreiten bis 30 mm
- ▶ *Profile width up to 30 mm*

Ihre Anfrage | *Your inquiry*  
sonder@kemmerhwmw.de ▶



**GLR** | **GripLock ROTATION Informationen**  
*GripLock ROTATION information*

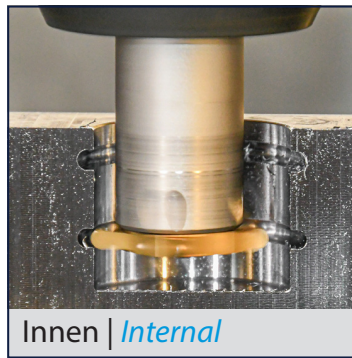
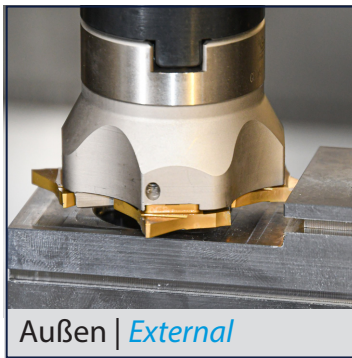

Der aktuelle ONLINEFLYER für Zirkularbearbeitung und Glockenwerkzeuge  
*ONLINE INFORMATION for circular milling and plunge tools*

Download ▶



**GLR** | **GripLock ROTATION - TAILORMADE Aufnahmen**  
*GripLock ROTATION - TAILORMADE tools*

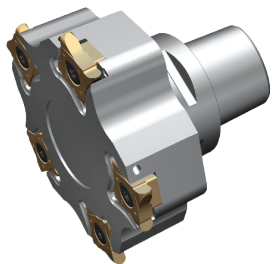

**GLR** | **GripLock ROTATION - TAILORMADE Beispiele Zirkularplatten**  
*GripLock ROTATION - TAILORMADE Examples for circular milling inserts*

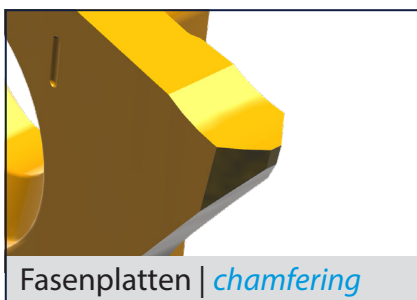

**Hinweise zu Ersatzteilen und Schnittwerten**  
*Information spare parts and parameters*



Alle Informationen hierzu, finden Sie in unserem Hauptkatalog.  
*Please find all information in our main catalogue.*





**KEMMER** | Der Stechdrehspezialist

